

TECHNICAL DATA SHEET

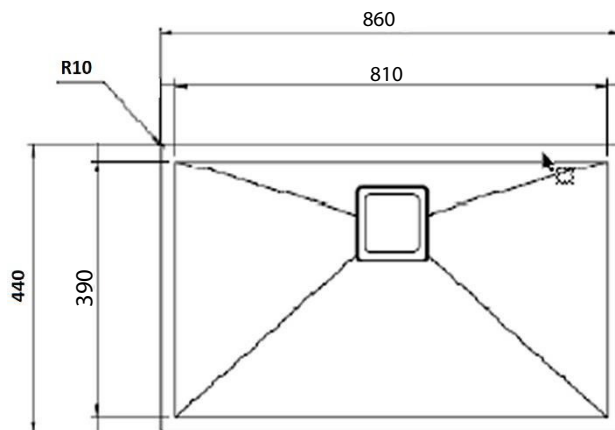

SERIES : **UNDERMOUNT** / SINK MATERIALS : **STAINLESS STEEL** / FAMILY : **LUXURY**



ARTICLE CODE :	HM8644 B SQ
DIMENSIONS :	860 X 440 MM
CUT OUT :	810 X 390 MM
BOWL DEPTH :	220 MM
INSTALLATION TYPE :	UNDERMOUNT
SURFACE FINISH :	BLACK
MATERIALS:	SUS 304
THICKNESS :	3 + 0.60 MM



WASTE FITTING



BOTTLE TRAP